

OSRAM SPL S4L90A_3 A01

Datasheet

Published by **ams-OSRAM AG**

Tobelbader Strasse 30, 8141 Premstaetten, Austria

Phone +43 3136 500-0

ams-osram.com

© All rights reserved



SMT Laser

SPL S4L90A_3 A01

4 Channel SMT Laser in QFN package

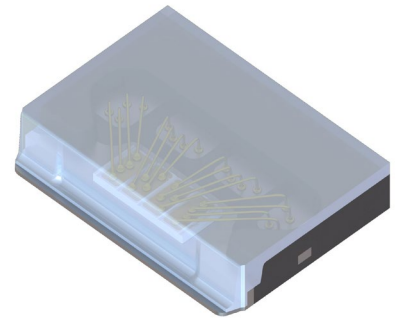

Applications

- 3D Sensing
- CCTV Surveillance
- Industrial Automation (Machine Controls, Light Barriers, Vision Controls)
- LIDAR, Pre-Crash, ACC
- Pedestrian Protection / Lane Departure Warning

Features

- Qualifications: AEC-Q102 Qualified
- Laser wavelength 905 nm
- 4 channel pulsed laser module
- Suited for short laser pulses from 1 to 100 ns
- SMT device

Ordering Information

Type	Peak output power typ. $I_F = 40 \text{ A}$; $t_p = 100 \text{ ns}$; $D = 0.01 \%$; $T_s = 25 \text{ °C}$ P_{opt}	Ordering Code
SPL S4L90A_3 A01	120 W	Q65112A6167

Maximum Ratings

$T_s = 25\text{ °C}$

Parameter	Symbol	Values	
Operating temperature	T_{op}	min.	-40 °C
		max.	105 °C
Storage temperature	T_{stg}	min.	-40 °C
		max.	125 °C
Junction temperature	T_j	max.	125 °C
Forward current	I_F	max.	40 A
Pulse width (FWHM)	t_p	max.	100 ns
Duty cycle $T_s = 105\text{ °C}$; all channels ON	dc	max.	0.05 %
Duty cycle $T_s = 105\text{ °C}$; one channel ON	dc	max.	0.2 %
Reverse voltage ¹⁾	V_R	max.	45 V

Characteristics

$I_F = 40 \text{ A}$; $t_p = 100 \text{ ns}$; $D = 0.01 \%$; $T_s = 25 \text{ °C}$

Parameter	Symbol		Values
Number of channels	N	typ.	4
Pitch	p	typ.	312 μm
Operating voltage	V_{op}	typ.	11 V
Peak wavelength	λ_{peak}	typ.	908 nm
Centroid wavelength ²⁾	$\lambda_{centroid}$	min. typ. max.	895 nm 905 nm 915 nm
Spectral bandwidth (FWHM)	$\Delta\lambda$	min. typ. max.	3 nm 7 nm 12 nm
Peak output power ³⁾	P_{opt}	min. typ. max.	105 W 125 W 145 W
Beam divergence (FWHM) parallel to pn-junction	Θ_{\parallel}	min. typ. max.	3 ° 10 ° 13 °
Beam divergence (FWHM) perpendicular to pn-junction	Θ_{\perp}	min. typ. max.	20 ° 25 ° 30 °
Beam divergence (1/e ²) parallel to pn-junction	Θ_{\parallel}	min. typ. max.	10 ° 13 ° 16 °
Beam divergence (1/e ²) perpendicular to pn-junction	Θ_{\perp}	min. typ. max.	35 ° 40 ° 50 °
Threshold current	I_{th}	typ.	0.6 A
Laser aperture (FWHM) parallel to pn-junction	W_{\parallel}	typ.	220 μm
Laser aperture (FWHM) perpendicular to pn-junction	W_{\perp}	typ.	10 μm
Thermal resistance junction solder point real ⁴⁾ all channels ON	$R_{thJS \text{ real}}$	typ. max.	17 K / W 20 K / W

Note: Unless otherwise specified, all values are valid for one emitter operated separately

Relative Spectral Emission ^{5), 6)}

$$I_{e,rel} = f(\lambda); I_F = 40A; P_{opt} = 125W; t_p = 100ns; D = 0.01\%$$

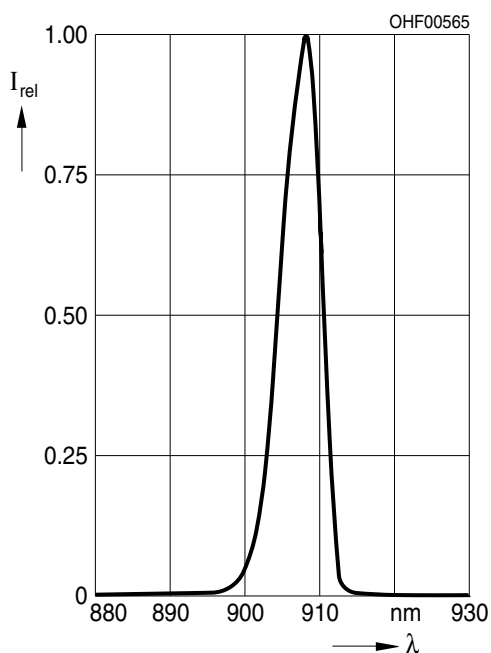

Far-Field Distribution Perpendicular to pn-Junction ^{5), 6)}

$$I_{rel} = f(\Theta_{\perp}); P_{opt} = 125W; t_p = 100ns; D = 0.01\%$$

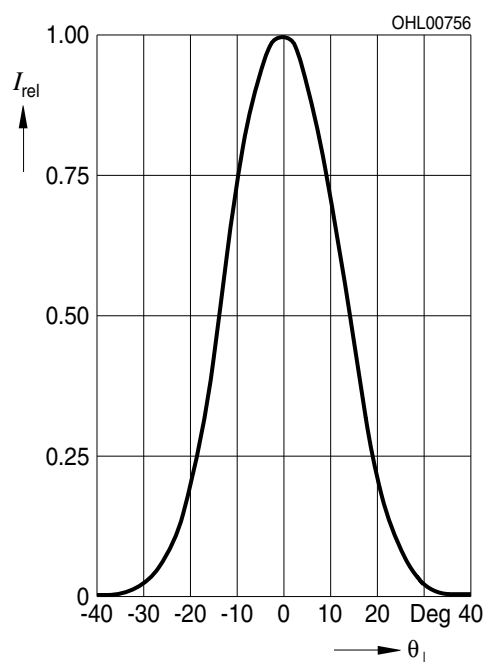

Far-Field Distribution Parallel to pn-Junction ^{5), 6)}

$I_{rel} = f(\Theta_{||})$; $P_{opt} = 125W$; $t_p = 100ns$; $D = 0.01\%$

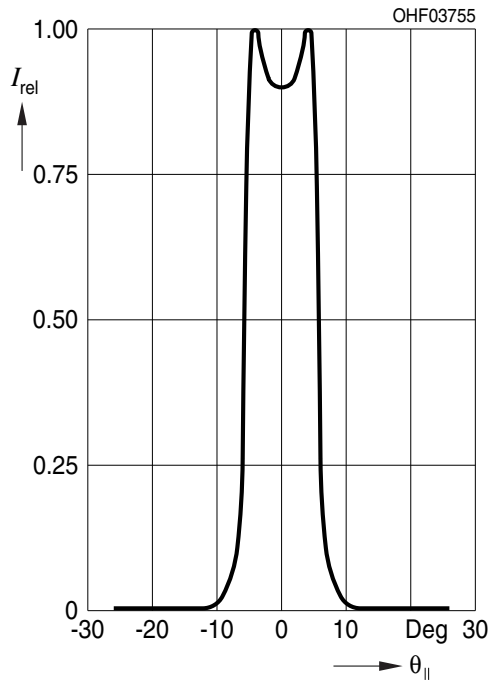

Near-Field Distribution Parallel to pn-Junction ^{5), 6)}

$I_{rel} = f(\Theta_{||})$; $P_{opt} = 125W$; $t_p = 100ns$; $D = 0.01\%$

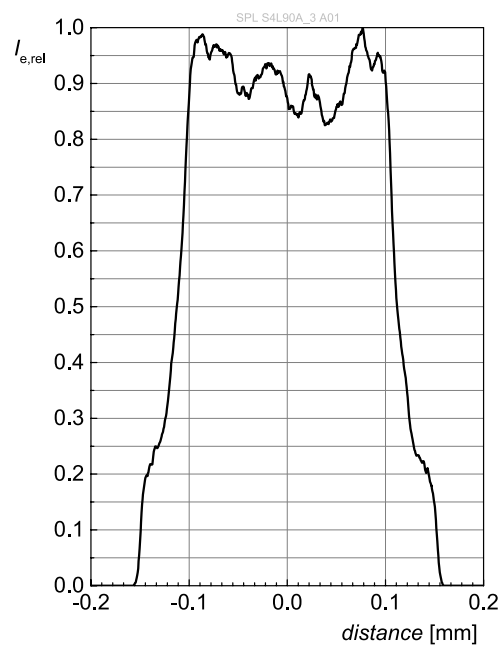

Near-Field Distribution Perpendicular to pn-Junction ^{5), 6)}

$I_{rel} = f(\Theta_{\perp}); P_{opt} = 125W; t_p = 100ns; D = 0.01\%$

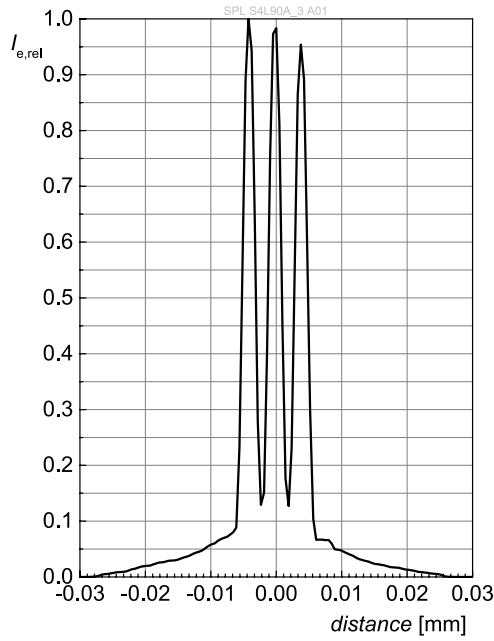

Optical Output Power ^{5), 6)}

$P_{opt} = f(I_F)$

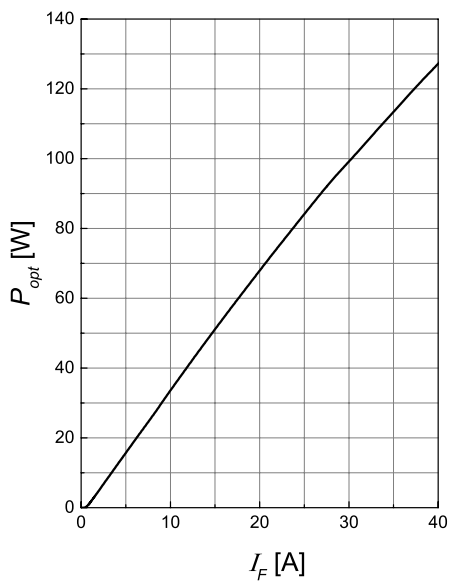

Centroid Wavelength ⁵⁾

$$\lambda_{\text{centroid}} = f(T_S); I_F = 40\text{A}; t_p = 100\text{ns}; D = 0.01\%$$

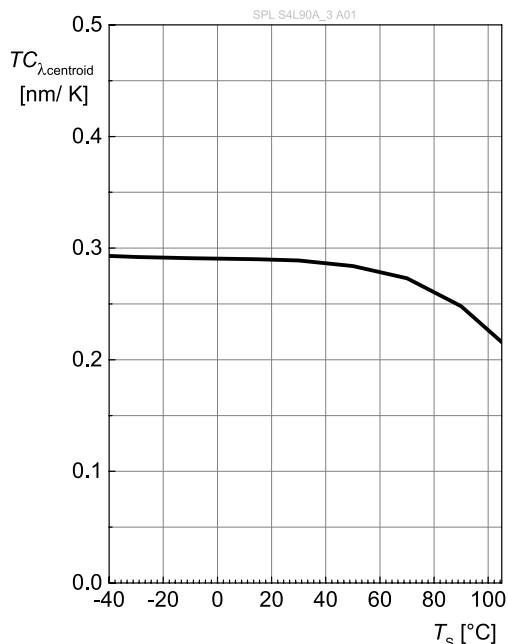

Centroid Wavelength ⁵⁾

$$\lambda_{\text{centroid}} = f(T_J); I_F = 40\text{A}; t_p = 100\text{ns}; D = 0.01\%$$

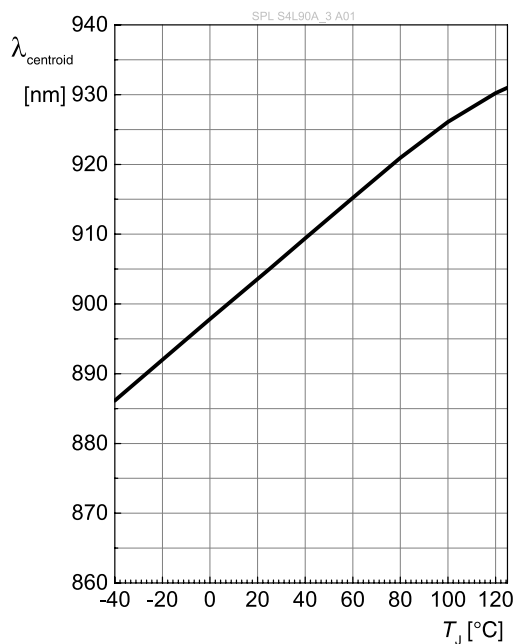

Centroid Wavelength ⁵⁾

$$\lambda_{\text{centroid}} = f(T_J); I_F = 40\text{A}; t_p = 100\text{ns}; D = 0.01\%$$

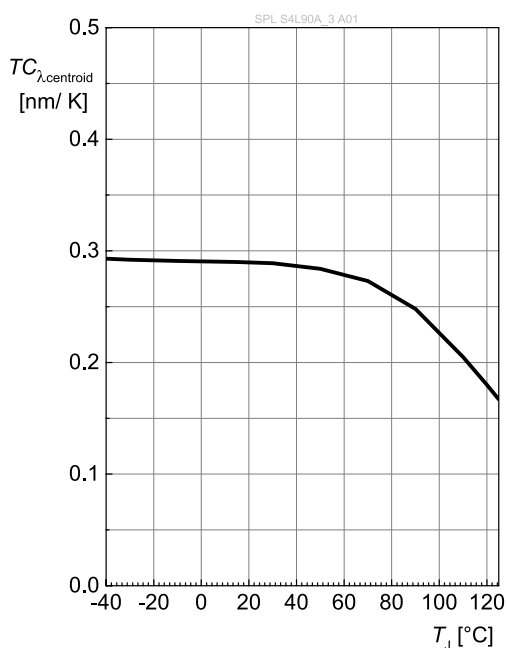

Centroid Wavelength ⁵⁾

$$\lambda_{\text{centroid}} = f(T_S); I_F = 40\text{A}; t_p = 100\text{ns}; D = 0.01\%$$

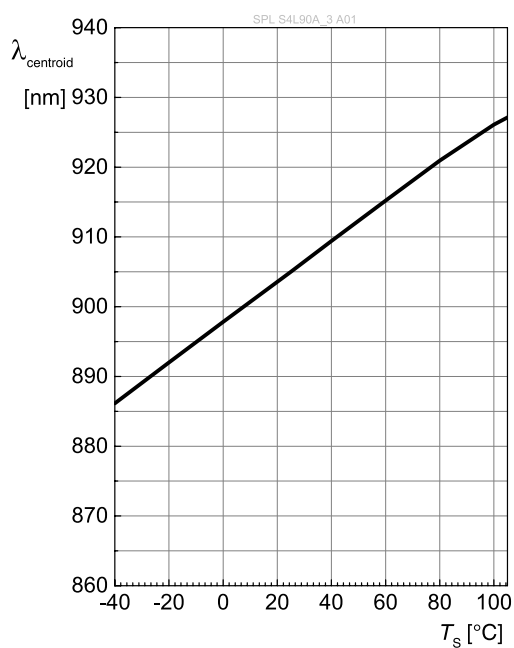

Peak Output Power

$$P_{opt} = f(T_S); I_F = 40A; t_p = 100ns; D = 0.01\%$$

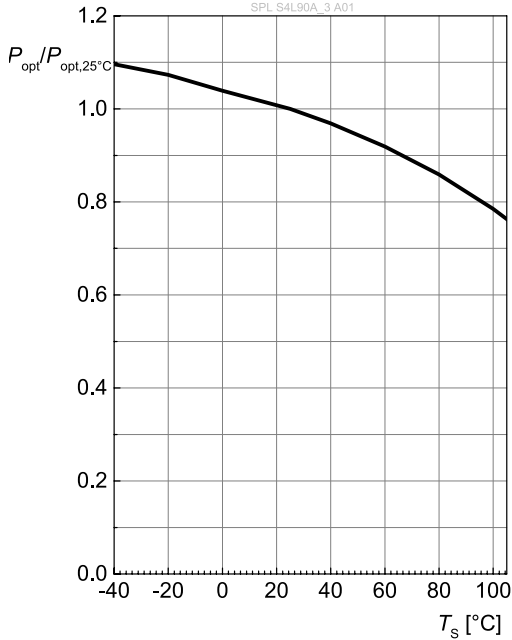

Peak Output Power

$$P_{opt} = f(T_J); I_F = 40A; t_p = 100ns; D = 0.01\%$$

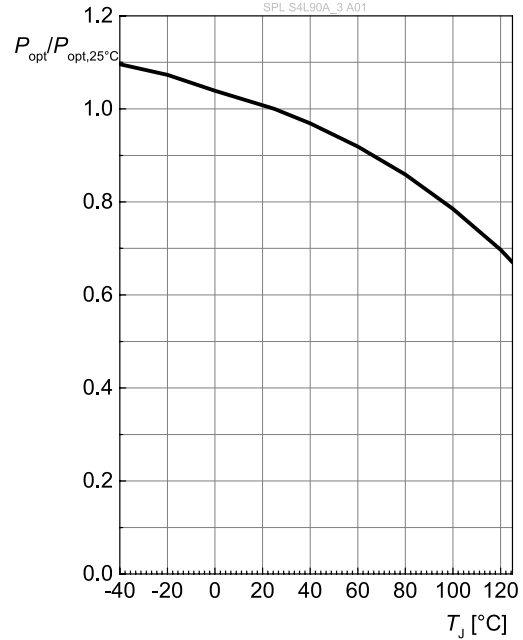

Permissible Pulse Handling Capability

$$I_F = f(t_p); D = \text{parameter}; P_{opt, typ}; R_{thjs, typ}; T_S = 85^\circ C$$

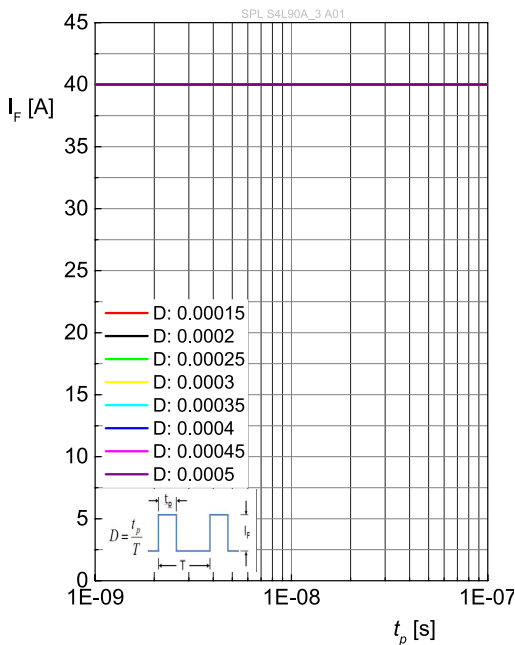

Permissible Pulse Handling Capability

$$I_F = f(t_p); D = \text{parameter}; P_{opt, min}; R_{thjs, max}; T_S = 85^\circ C$$

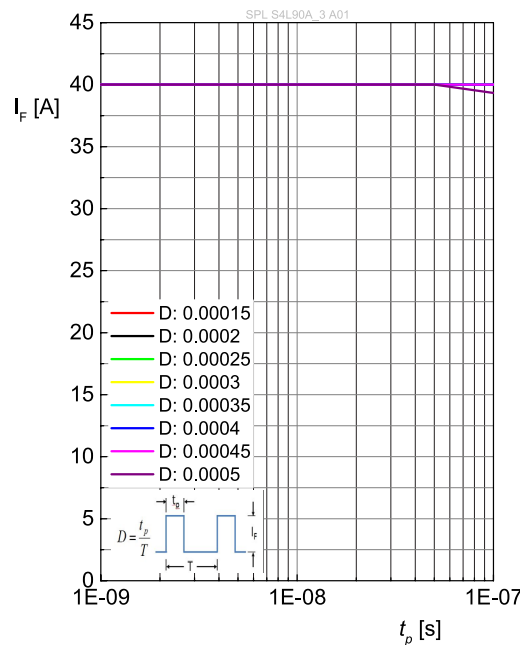

Permissible Pulse Handling Capability

$I_F = f(t_p)$; $D = \text{parameter}$; $P_{\text{opt, typ}}$; $R_{\text{thjs, typ}}$; $T_S = 105^\circ\text{C}$

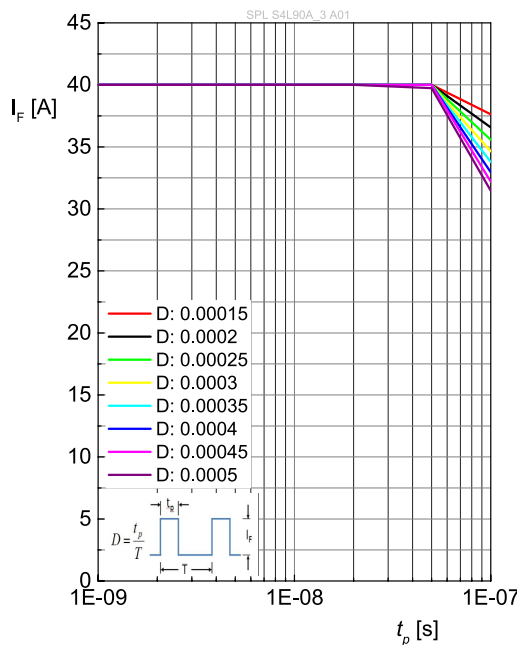

Permissible Pulse Handling Capability

$I_F = f(t_p)$; $D = \text{parameter}$; $P_{\text{opt, min}}$; $R_{\text{thjs, max}}$; $T_S = 105^\circ\text{C}$

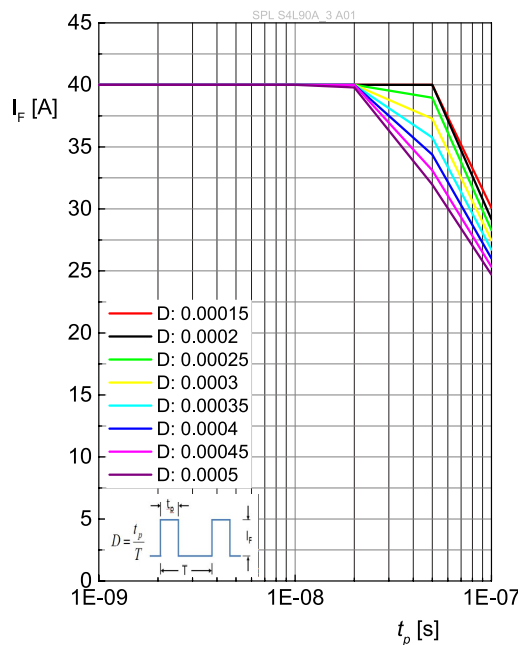

Dimensional Drawing ⁷⁾

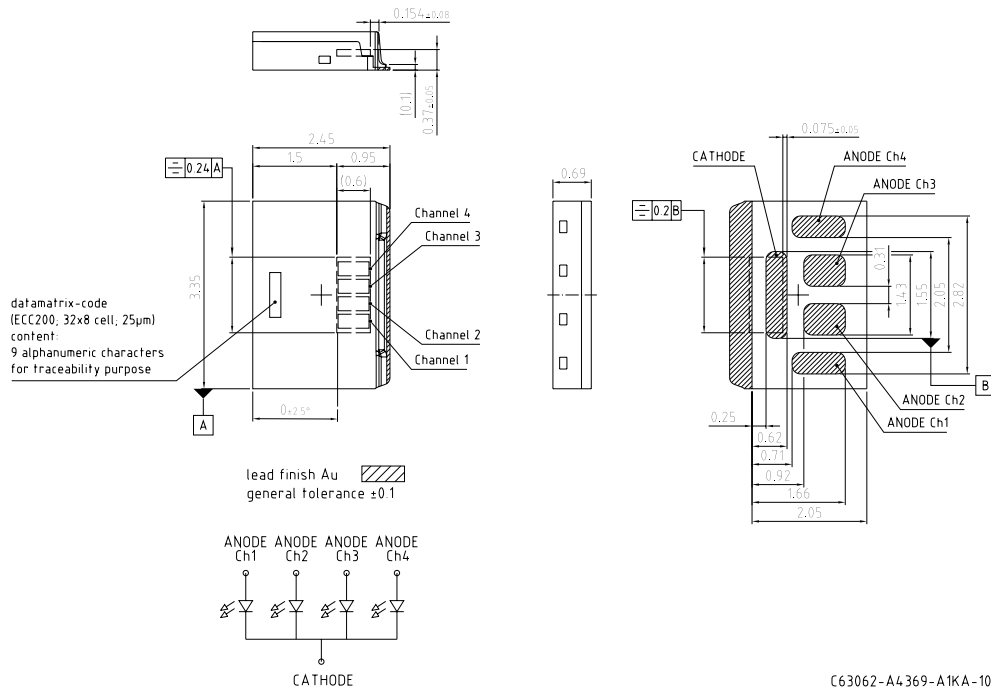

C63062-A4369-A1KA-10

Further Information:

Approximate Weight: 15.0 mg

Electrical Internal Circuit

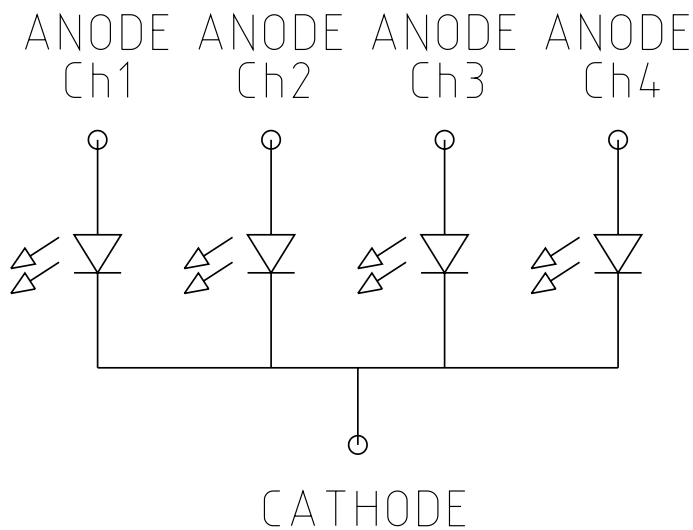

Recommended Solder Pad ⁷⁾

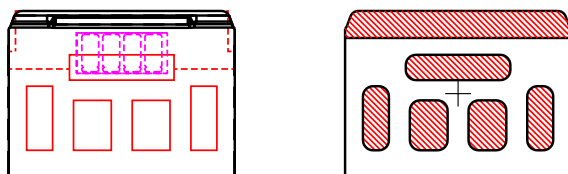
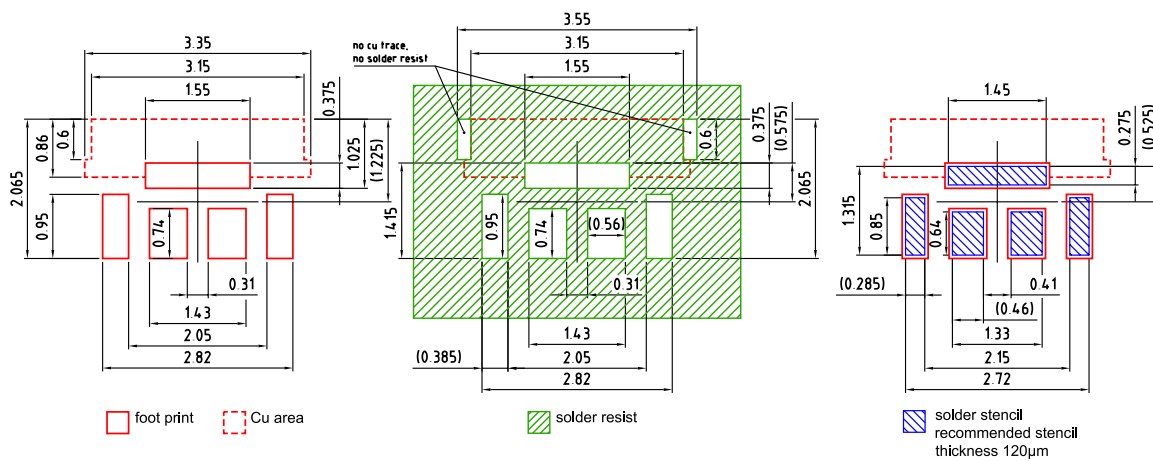

E062 3010 256 -03

Reflow Soldering Profile

Product complies to MSL Level 3 acc. to JEDEC J-STD-020E

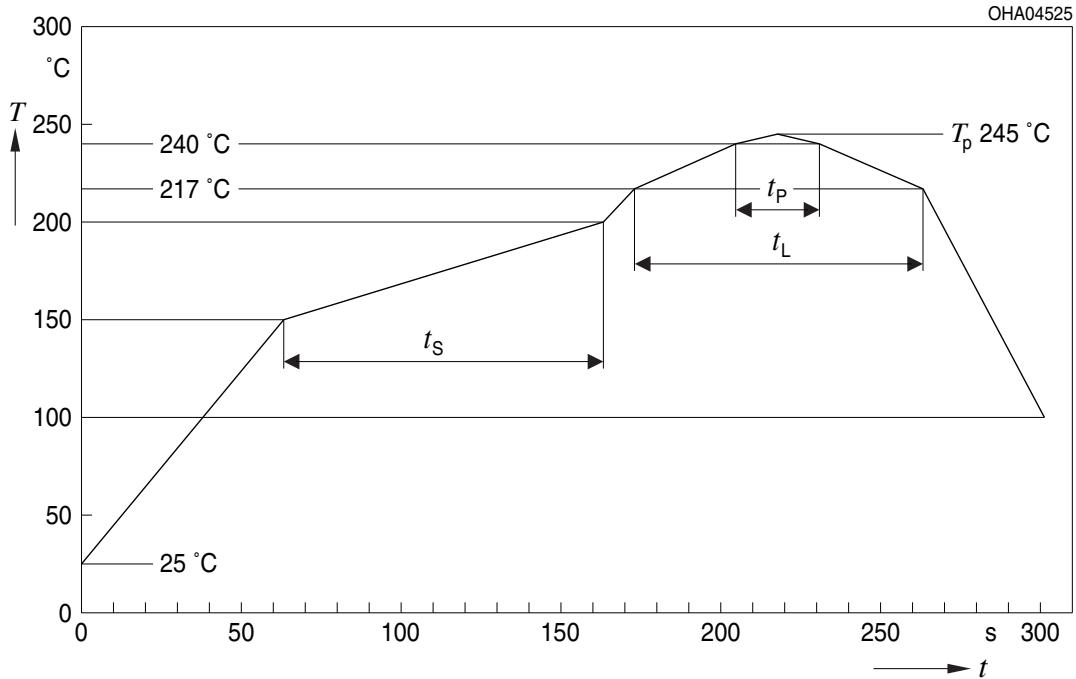

Profile Feature	Symbol	Pb-Free (SnAgCu) Assembly			Unit
		Minimum	Recommendation	Maximum	
Ramp-up rate to preheat ^{*)} 25 °C to 150 °C			2	3	K/s
Time t_s T_{Smin} to T_{Smax}	t_s	60	100	120	s
Ramp-up rate to peak ^{*)} T_{Smax} to T_p			2	3	K/s
Liquidus temperature	T_L		217		°C
Time above liquidus temperature	t_L		80	100	s
Peak temperature	T_p		245	260	°C
Time within 5 °C of the specified peak temperature $T_p - 5$ K	t_p	10	20	30	s
Ramp-down rate* T_p to 100 °C			3	6	K/s
Time 25 °C to T_p				480	s

All temperatures refer to the center of the package, measured on the top of the component
* slope calculation DT/Dt : Dt max. 5 s; fulfillment for the whole T-range

Taping ⁷⁾

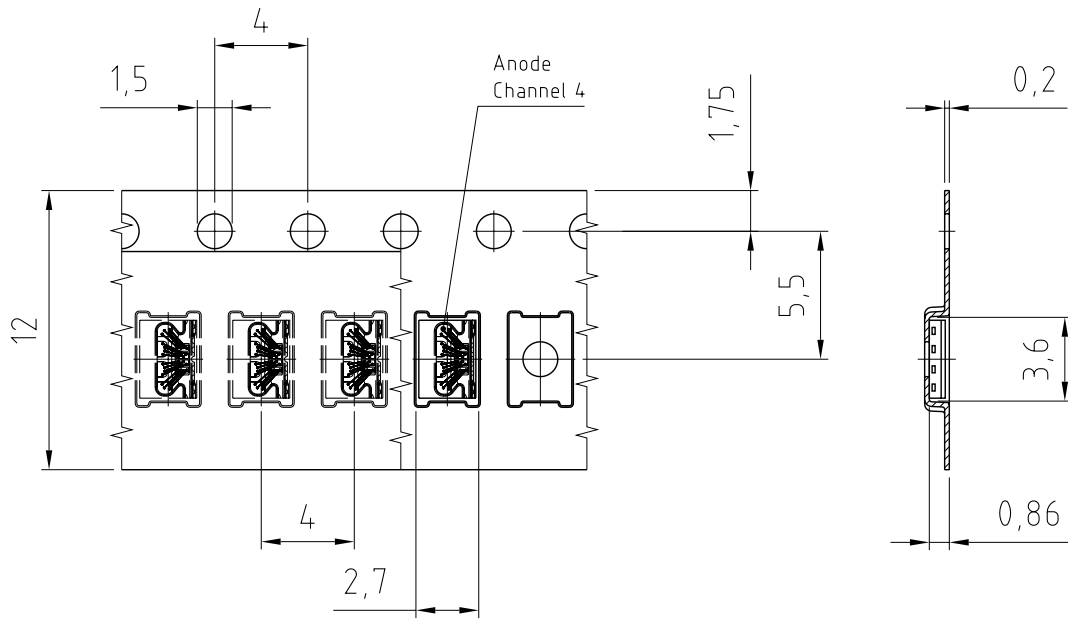

C63062-A4369-B10-03

Tape and Reel ⁸⁾

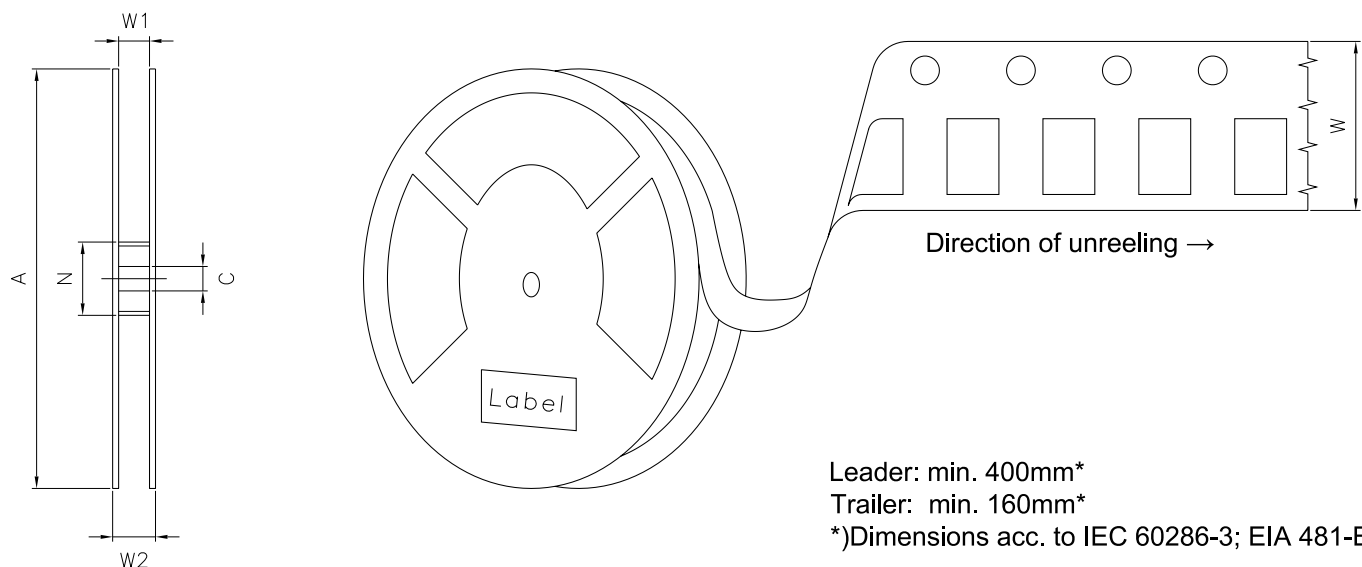

Reel Dimensions

A	W	N_{\min}	W_1	$W_{2\max}$	Pieces per PU
180 mm	$12 + 0.3 / - 0.1$ mm	60 mm	$12.4 + 2$ mm	18.4 mm	500

Barcode-Product-Label (BPL)

OSRAM Opto Semiconductors LX XXXX BIN1: XX-XX-X-XXX-X





RoHS Compliant

(6P) BATCH NO: 1234567890 ML Temp ST
X XXX °C X

(1T) LOT NO: 1234567890 (9D) D/C: 1234

Pack: RXX
DEMY XXX
X_X123_1234.1234 X

(X) PROD NO: 123456789(Q)QTY: 9999 (G) GROUP: XX-XX-X-X

OHA04563

Dry Packing Process and Materials ⁷⁾

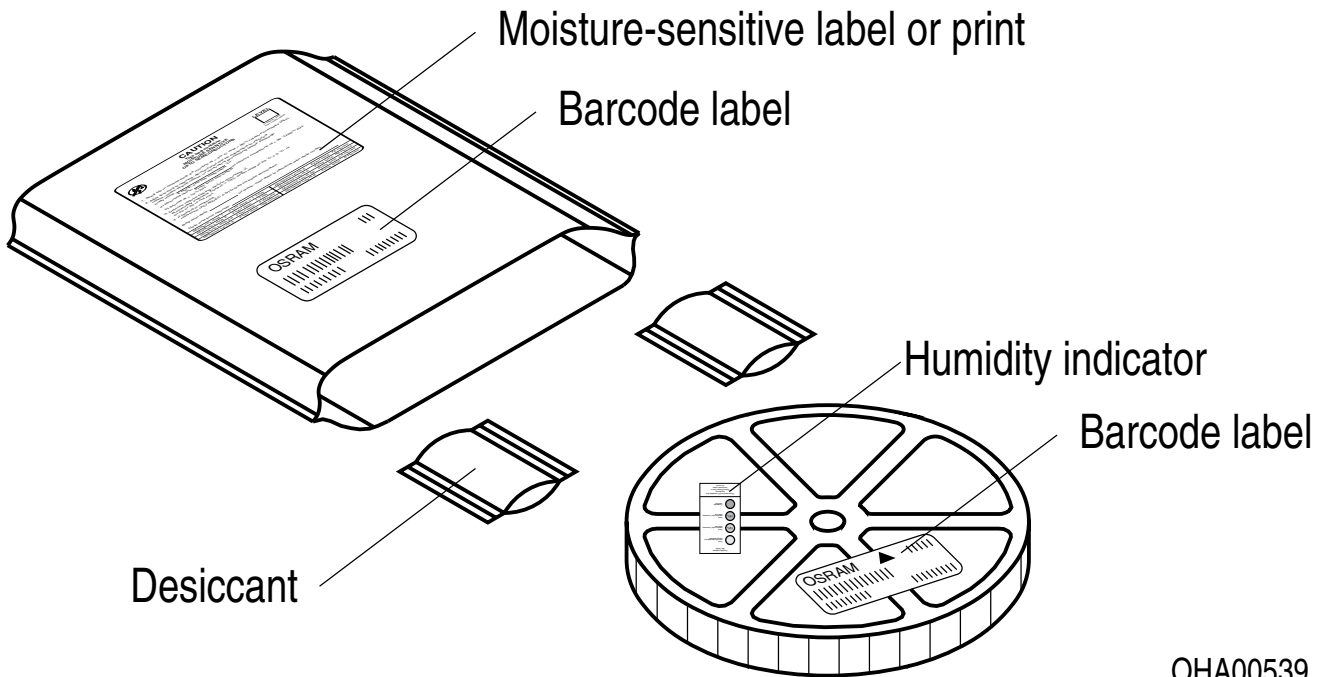

OHA00539

Moisture-sensitive product is packed in a dry bag containing desiccant and a humidity card according JEDEC-STD-033.

Notes

Depending on the mode of operation, these devices emit highly concentrated visible and non visible light which can be hazardous to the human eye. Products which incorporate these devices have to follow the safety precautions given in IEC 60825-1.

Subcomponents of this device contain, in addition to other substances, metal filled materials including silver. Metal filled materials can be affected by environments that contain traces of aggressive substances. Therefore, we recommend that customers minimize device exposure to aggressive substances during storage, production, and use. Devices that showed visible discoloration when tested using the described tests above did show no performance deviations within failure limits during the stated test duration. Respective failure limits are described in the IEC60810.

Tape and Reel:

Packing unit can vary 2 % from the stated value.

For further application related information please visit www.osram-os.com/appnotes

Disclaimer

Attention please!

The information describes the type of component and shall not be considered as assured characteristics. Terms of delivery and rights to change design reserved. Due to technical requirements components may contain dangerous substances.

For information on the types in question please contact our Sales Organization.

If printed or downloaded, please find the latest version on our website.

Packing

Please use the recycling operators known to you. We can also help you – get in touch with your nearest sales office. By agreement we will take packing material back, if it is sorted. You must bear the costs of transport. For packing material that is returned to us unsorted or which we are not obliged to accept, we shall have to invoice you for any costs incurred.

Product and functional safety devices/applications or medical devices/applications

Our components are not developed, constructed or tested for the application as safety relevant component or for the application in medical devices.

Our products are not qualified at module and system level for such application.

In case buyer – or customer supplied by buyer – considers using our components in product safety devices/ applications or medical devices/applications, buyer and/or customer has to inform our local sales partner immediately and we and buyer and /or customer will analyze and coordinate the customer-specific request between us and buyer and/or customer.

Glossary

- 1) **Reverse Operation:** This product is intended to be operated applying a forward current within the specified range. Applying any reverse bias shall be avoided.
- 2) **Wavelength:** The wavelengths are measured with a tolerance of ± 1 nm.
- 3) **Brightness:** The brightness values are measured with a tolerance of $\pm 11\%$.
- 4) **Thermal resistance:** junction - soldering point, of the device only, mounted on an ideal heatsink (e.g. metal block)
- 5) **Typical Values:** Due to the special conditions of the manufacturing processes of semiconductor devices, the typical data or calculated correlations of technical parameters can only reflect statistical figures. These do not necessarily correspond to the actual parameters of each single product, which could differ from the typical data and calculated correlations or the typical characteristic line. If requested, e.g. because of technical improvements, these typ. data will be changed without any further notice.
- 6) **Testing temperature:** TA = 25°C (unless otherwise specified)
- 7) **Tolerance of Measure:** Unless otherwise noted in drawing, tolerances are specified with ± 0.1 and dimensions are specified in mm.
- 8) **Tape and Reel:** All dimensions and tolerances are specified acc. IEC 60286-3 and specified in mm.

Revision History

Version	Date	Change
1.0	2022-02-21	Initial Version New Layout



EU RoHS and China RoHS compliant product

此产品符合欧盟 RoHS 指令的要求；
按照中国的相关法规和标准，
不含有毒有害物质或元素。

Published by ams-OSRAM AG

Tobelbader Strasse 30, 8141 Premstaetten, Austria

Phone +43 3136 500-0

ams-osram.com

© All rights reserved

am 

OSRAM